

平面化三軸自旋閥巨磁阻感測器

Planarized 3-axis spin-valve GMR sensor

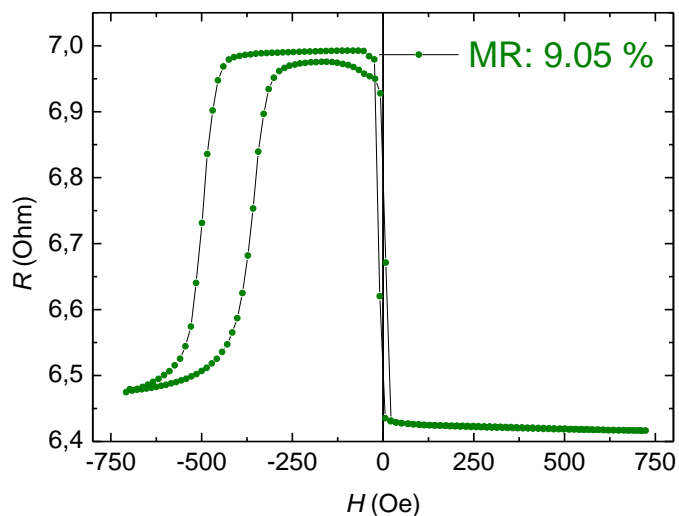

Ta [2 nm]	
Ir/Mn [10 nm]	Ir25%Mn75%
Co/Fe [2.5 nm]	
Cu [2.2 nm]	
Co/Fe [1.5 nm]	Co80%Fe20%
Ni/Fe [3 nm]	Ni80%Fe20%
Ta [5 nm]	
Si/SiO <sub>2</sub>	

CMOS-MEMS三軸通量閘磁場感測器

CMOS-MEMS 3-axis fluxgate magnetic field sensor

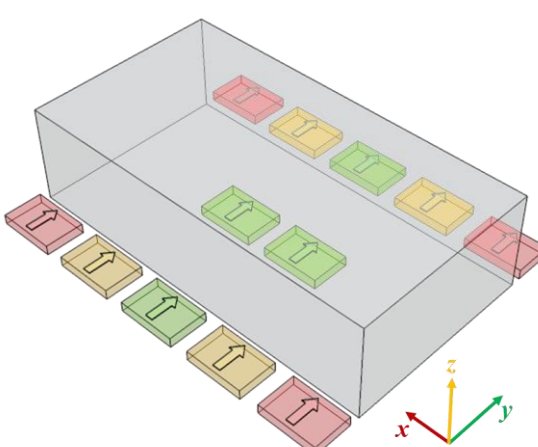
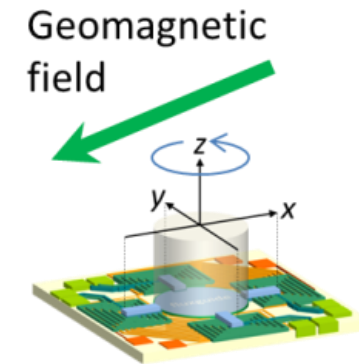
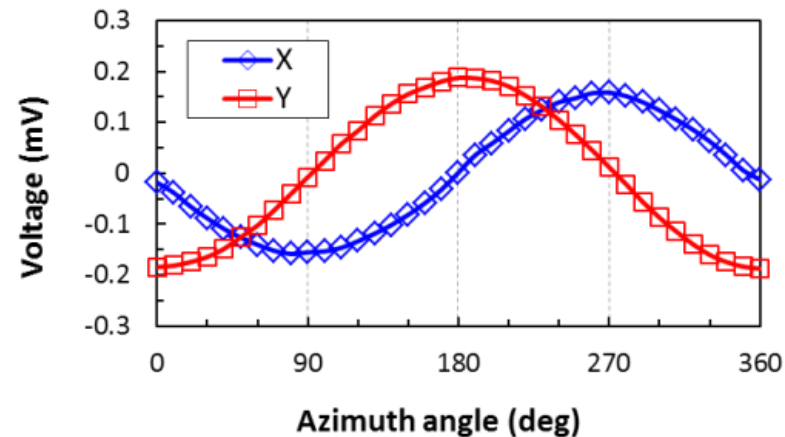

IEEE Nanotechnology Council  
2018 Best Paper Award

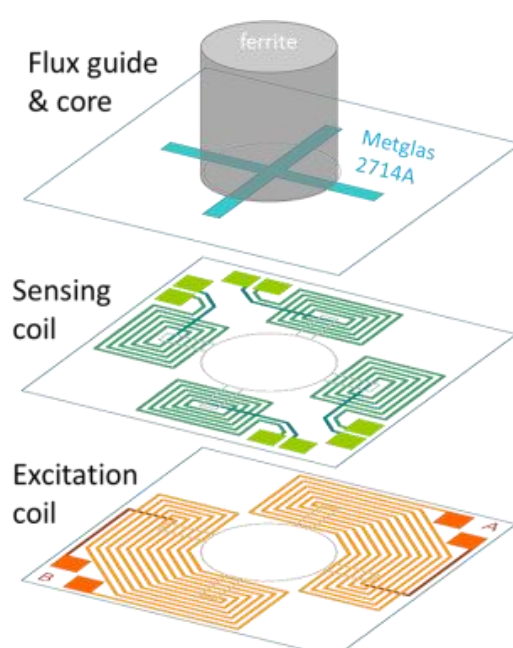

2018  
旭泰科技論文金獎

輸電導線渦電流檢測  
Eddy-current detection for power cables

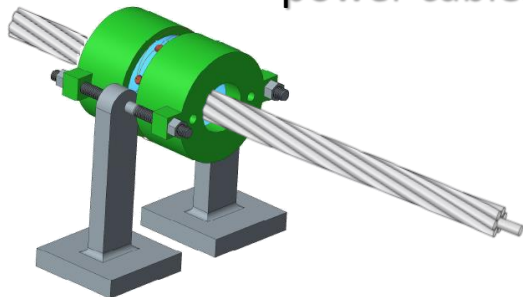

高頻寬電流感測器  
High-bandwidth current sensor

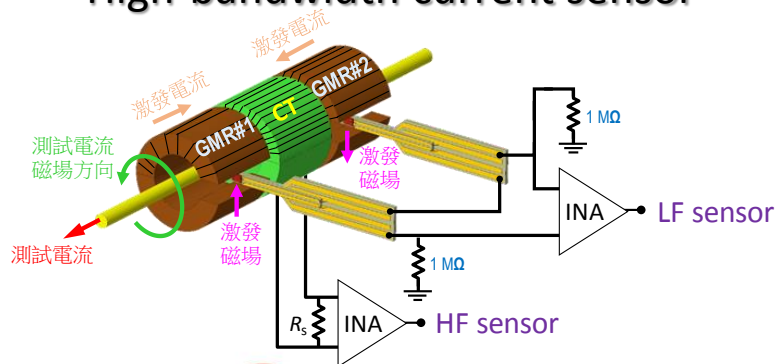

通量閘電流感測器  
Fluxgate current sensor

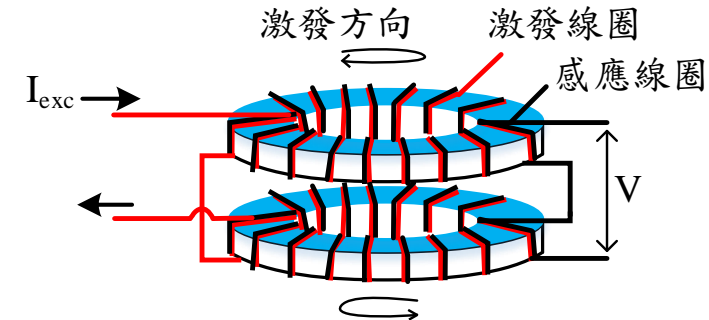

2019  
旭泰科技論文佳作



2019  
智慧生活  
科技研討會

最佳論文



2018  
旭泰科技論文  
優良創意獎

金屬檢測 Metal Detection

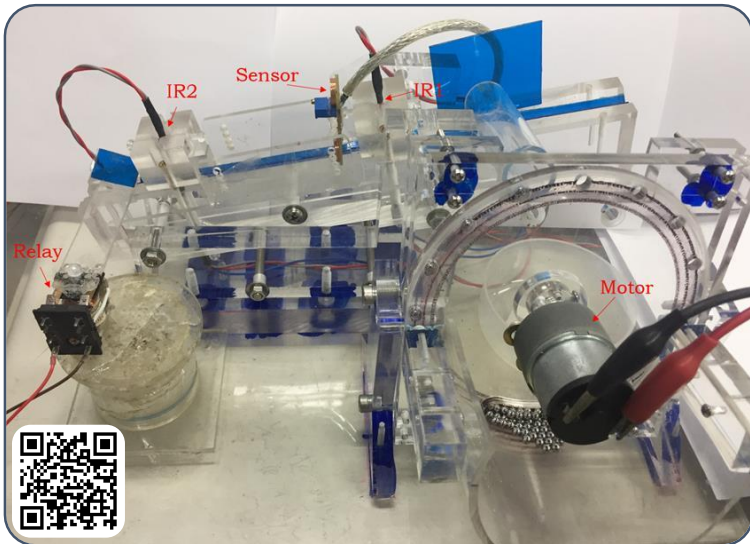

位置追蹤 Position tracking

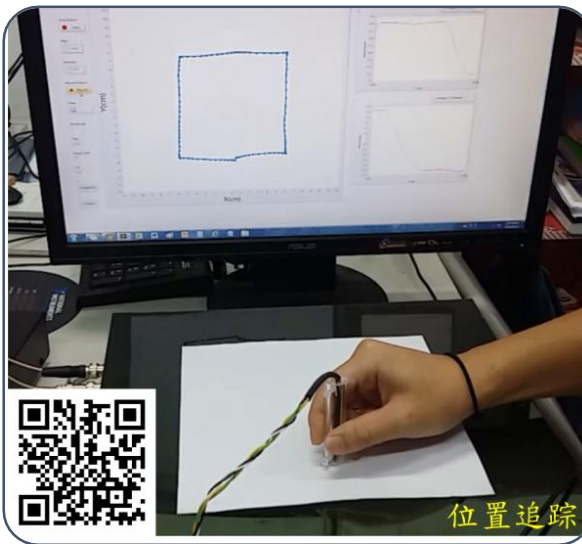

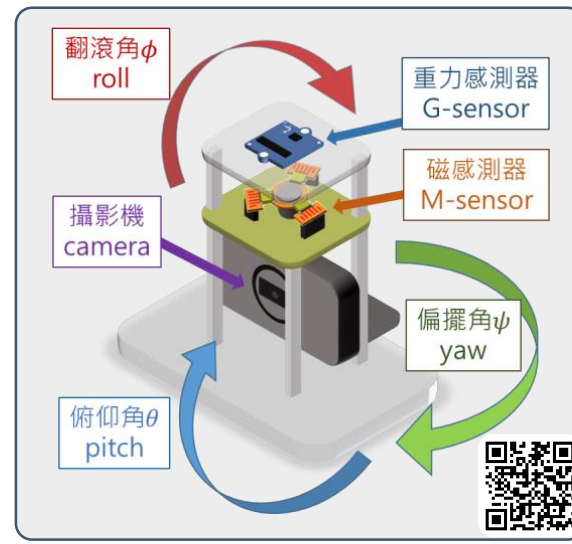

運動感測 Motion sensing

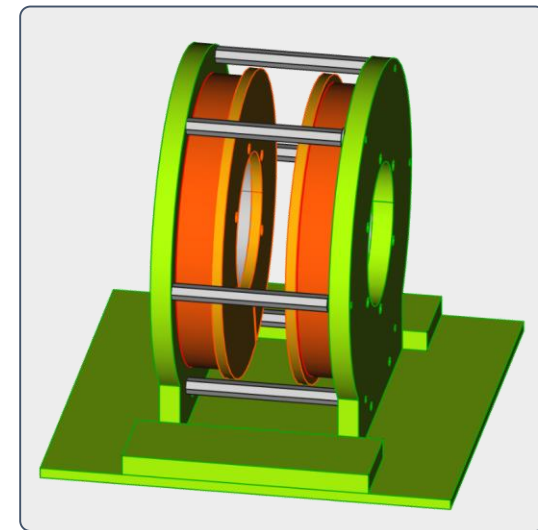

線圈設計 Coil design

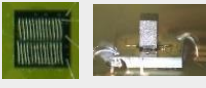

磁感測器 Magnetic sensors

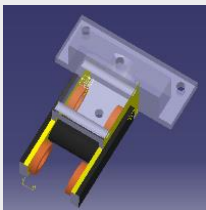
-  微通量閘  
Micro Fluxgates
-  自旋閘巨磁阻  
GMR spin-valve
-  渦電流感測器  
Eddy-current sensor

電流感測 Current sensing

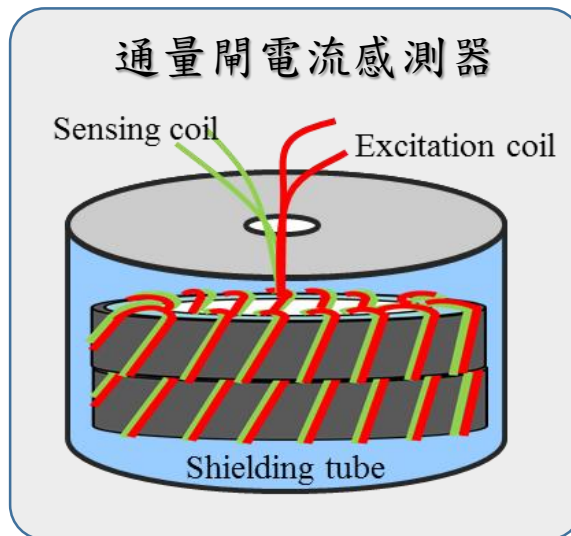

磁源映像 Magnetic source imaging

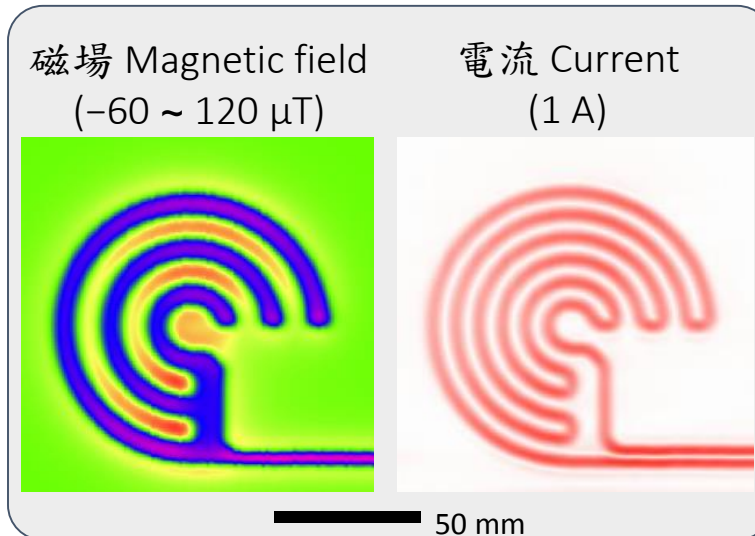

合作夥伴 Partners

-  TAIPEI TECH
-  TAN KONG
-  PMR
-  sentek 愛盛科技
-  工業技術研究院  
Industrial Technology Research Institute
-  金屬工業研究發展中心  
METAL INDUSTRIES RESEARCH & DEVELOPMENT CENTRE